

McIntosh

STEREO PREAMP-AMPLIFIER

MA230

TABLE OF CONTENTS

GENERAL DESCRIPTION _____	1
TECHNICAL DESCRIPTION _____	1
Mechanical Specifications_____	3
Electrical Specifications_____	3
FRONT PANEL INFORMATION _____	5
INSTALLATION _____	9
CONNECTIONS _____	11
AC Connections_____	11
Ground Connection_____	11
Tape Output Connections_____	12
Loudspeaker Connections_____	12
AC Power_____	12
Input Connections_____	12
OPERATING INSTRUCTIONS _____	14
GUARANTEE _____	20
3-YEAR FACTORY SERVICE CONTRACT _____	20



OWNER'S MANUAL

MA230 PREAMP-AMPLIFIER

GENERAL DESCRIPTION

The new McIntosh MA230 presents two outstanding "FIRSTS" for your home stereo listening enjoyment.

. . . The MA230 is the FIRST stereo preamp-amplifier on one chassis that meets the traditional rigorous McIntosh engineering performance standards.

. . . The MA230 is the FIRST stereo instrument to combine a solid state preamplifier with a tube and transformer power amplifier on the same chassis.

The McIntosh MA230 has eliminated all previous limitations of single chassis preamp-power amplifiers. The compact design of the MA230 preamplifier allows adequate space on the same chassis for a cool running 30 watt per channel tube power amplifier. You can now enjoy McIntosh performance and reliability with the convenience of a complete single chassis stereo instrument.

The dramatic difference in the quality of music reproduction through McIntosh instruments is due directly to low distortion per-

formance. McIntosh Laboratory is the only manufacturer in the entire industry to guarantee and deliver the lowest distortion at all audio frequencies.

Long life, flexibility, and highest quality construction are characteristic designs in every McIntosh instrument. Wide electrical and thermal margins of safety for all components, transistors and tubes add to the long life built into every McIntosh product. Advanced engineering and cool operating design insure reliability and low maintenance costs. A McIntosh instrument is without doubt the most economical and worthwhile long term investment in the high fidelity industry.

Once you have enjoyed the outstanding performance of the MA230, you will understand why McIntosh products have earned their reputation as "THE BEST." Your McIntosh MA230 stereo preamp-amplifier will give you years of the finest possible performance and will become a highly valued part of your home music system.

TECHNICAL DESCRIPTION

The new McIntosh MA230 combines, for the first time, a McIntosh engineered stereo solid state preamplifier and tube power amplifier on the same chassis. Long months of diligent research by the McIntosh engineering staff have produced a compact solid state preamplifier which meets all the traditional McIntosh performance standards. The MA230 solid state preamplifier eliminates the drawbacks and limitations of all previous solid state circuits. The compact design of this preamplifier has allowed sufficient space to properly position a 30 watt per channel stereo tube power amplifier on the same chassis.

The MA230 continues the McIntosh reputation for cool and efficient operation. Careful chassis planning has permitted the output

tubes to be spaced well apart. This wide spacing allows more air circulation around the tubes. Better air circulation means cooler operation. Cooler operation means longer trouble free life. The large McIntosh output and power transformers are positioned across the center of the chassis for mechanical stability and strength.

The MA230 preamplifier section is designed around the latest type Silicon-Planar transistors. Silicon-Planar transistors were selected because of their high thermal stability, low leakage, low noise, and superior high frequency response. A total of 12 transistors are used. Three transistors are used in each channel of the phono preamplifier section. Three transistors are also used in

each channel of the tone control section. The entire preamplifier has low noise, low distortion, and is not affected by normal room temperature variations.

Typical McIntosh care in design protects against input signal overload. Both the high level inputs (Tuner, Tape and Aux) and the low level phono and tape head inputs can accept much higher than average input signals without overload.

For example, at 2000 cycles the phono inputs can accept 150 millivolts of signal before overload. No magnetic phono cartridge now available is capable of even one half this output voltage.

PREAMPLIFIER

Each channel of the Phono preamplifier section uses 3 transistors. The first input stage is a high gain amplifier. The output of this transistor feeds a pair of transistors connected in a Darlington configuration. A negative feedback loop connects from the output of the Darlington pair back to the emitter of the first stage transistor. This feedback loop reduces noise and distortion and also provides accurate frequency compensation for phono records and tape head playback. Negative feedback remains in effect even at 20 cycles where gain is highest, to insure low distortion over the entire frequency range.

The phono input impedance is 47,000 ohms to match most magnetic phono cartridges. Other resistors may be added to match the occasional cartridge which requires a different input impedance.

The Tape Head input impedance is slightly over 1 megohm for uniform high frequency response with typical tape playback heads.

The Tape Outputs come directly from the Selector Switch and provide signal level sufficient for feeding a tape recorder. For example, 10 millivolts of signal at the phono input results in 1.6 volts at the Tape Output.

The high level inputs feed through the Balance and Volume controls into a transistor connected as an Emitter-Follower. This transistor is the first stage of the Tone Control section. The impedance of the high level inputs is 250,000 ohms. Any conventional

tuner or tape recorder may be connected to the MA230 without loss of low frequencies. The emitter-follower provides the required high input impedance and low output impedance for feeding the tone control negative feedback circuits. The last two stages of the tone control section are two transistors in a Darlington configuration similar to the phono preamplifier. The high gain of these stages is used to advantage for the tone control negative feedback circuits. This type of circuit assures low distortion and the correct shape for the tone control response curves. Negative feedback is maintained at all frequencies, even with the tone controls turned to full boost. Distortion is, therefore, kept very low, even at the frequencies where maximum boost occurs. The total distortion of the entire MA230 preamplifier circuit is actually only a few hundredths of 1 percent.

POWER AMPLIFIER

The output of the solid state preamplifier feeds into one half of a 12AX7 dual triode tube. The two triode sections of the 12AX7 are the first stage voltage amplifiers in each channel of the power amplifier. The output of each 12AX7 is direct-coupled to a 12AU7 tube used as a grounded-grid inverter-driver. The balanced output voltages of the grounded-grid inverter are precisely maintained in amplitude over the entire audio frequency range. The inverter output balance is controlled by precise plate load resistors. An adjusting control is also included in the inverter plate circuit to insure exact signal balance and minimum low frequency distortion. This control is factory set using a distortion analyzer. Normally, the mid point setting of this control is adequate to keep overall distortion less than ½ of 1% at full output.

The outputs of the 12AU7 tubes are coupled through mylar-insulated capacitors to the output tube grids. These capacitors are the only coupling capacitors used in the power amplifier circuit, which keeps phase shift very low at low frequencies.

The 7591 output tube plates are coupled to the speaker through a special McIntosh engineered output transformer. A separate tertiary winding on the transformer also

couples the output tube cathodes into the transformer. Six db of negative feedback is produced in the output stage with this circuit.

Twenty db of negative feedback around the entire power amplifier circuit is achieved by coupling a special secondary winding on the output transformer back to the first stage 12AX7 cathode.

The fixed bias on the 7591 output tubes is adjustable over a small range with individual controls. These adjustments are factory set to 0.7 volts DC at the test points. Convenient test point jacks are provided next to each output tube. The setting of these controls is not critical and need not be touched in normal use. To assure best possible performance of the MA230 over long periods of operation, or whenever output tubes are changed, the bias can be checked and reset if necessary.

A pair of stereo headphone jacks is provided on the front panel. The jacks are connected to the amplifier outputs through 100 ohm resistors for low impedance headphones. The speaker switch turns off the speakers for headphone listening.

POWER SUPPLY

A silicon rectifier voltage doubler power supply assures stable voltages and cool operation. A zener diode holds the transistor pre-amplifier operating voltages at exact values and eliminates all traces of hum.

A thermistor is used in the primary AC circuit of the power transformer to protect against line voltage surges and extend tube and transistor life. The thermistor places slightly more than 25 ohms in the AC circuit when cold. As the amplifier warms up the thermistor also warms and its resistance then drops to less than 0.7 ohm. The amplifier then operates at normal line voltages but is protected during the initial warmup period. Again, McIntosh care in engineering protects your investment in listening pleasure.

The combination of these features results in performance available only from a McIntosh amplifier. The MA230 delivers 30 watts RMS continuous power from both channels at the same time, 20 cycles through 20,000 cycles with harmonic distortion less than ½ of 1%. This superior level of performance is unequaled by any other preamplifier. A listening test quickly proves the superiority of the McIntosh MA230.

MECHANICAL SPECIFICATIONS

Size

Front panel, 16 inches wide by $5\frac{7}{16}$ inches high; chassis, 15 inches wide by $4\frac{1}{2}$ inches high by $14\frac{1}{2}$ inches deep, including connectors. Clearance in front of mounting panel including knobs, $1\frac{1}{2}$ inches.

Weight

43 pounds net, 57 pounds in shipping carton.

Finish

Anodized gold and black (Front Panel).

ELECTRICAL SPECIFICATIONS

Power Output

30 watts continuous per channel with both channels operating simultaneously. 60 watts continuous, monophonic.

Harmonic Distortion

Less than 0.5% at 30 watts output, 20 cycles through 20,000 cycles. Distortion decreases as power output is reduced.

Intermodulation Distortion

Less than 0.5% for any combination of frequencies from 20 cycles through 20,000 cycles if instantaneous peak power is 60 watts per channel or less.

Phase Shift, Power Amplifier-

Less than $\pm 5^\circ$ 20 to 20,000 cycles.

Frequency Range

At 30 watts output both channels.
+0, -0.5db 20 cycles through 20,000 cycles.
+0, -3db 15 cycles through 70,000 cycles.

Output Impedance

4 ohms, 8 ohms, 16 ohms.

Internal Impedance/Damping

Less than 10% of rated load impedance; damping factory of 10.

Input Sensitivity and Impedance

Auxiliary, Tape, Tuner, and Tape Monitor:
.25 volts, 250K ohms.
Phono 1 and Phono 2: 1.5 millivolts, 47,000 ohms.
Tape Head: 1.5 millivolts, 1 Megohm.

Total Noise (including Power Amplifier)

High level inputs: 75db below rated output.
Low level inputs: 60db below rated output;
less than 4.0 microvolts at input terminals.

Tape Output

.25 volts into 25,000 ohms with rated input;
1.6 volts with 10 millivolts at Phono input.

Left Plus Right Output

10 volts from generator impedance of 5,000 ohms.

Bass Controls

±18db at 20 cycles, with friction clutch for independent adjustment of each channel.

Treble Controls

± 18db at 20,000 cycles, with friction clutch for independent adjustment of each channel.

Comp (Compensator) Switch

RIAA or LP phono equalization.

Tape Switch

Normal or Tape Monitor.

Phase Switch

Normal (0°) or reverse (180°).

Speaker Switch

Speakers ON, or OFF for headphone listening.

HF Filter

Flat, or 5,000 cycle cutoff, 12db per octave.

LF Filter

Flat, or 50 cycle cutoff, 12db per octave.

Loudness Switch

Normal or compensated bass and treble.

Headphone Jacks

Two, for two pairs of headphones.

Input Selector

6 positions: AUX, TAPE, TUNER, PHONO 1, PHONO 2, TAPE HD.

Mode Selector

7 positions: L to L and R, R to L and R, STEREO REVERSE, STEREO, MONO (L+R), L+R to L, L+R to R.

Transistor Complement (Preamplifier)

8-2N2926 Silicon Planar
4-11BQ101 Silicon Planar

Tube Complement (Power Amplifier)

4-7591 Power Output
2-12AU7 Driver/Phase Inverter
1-12AX7 1st Audio Voltage Amplifier

Power Requirements

120-125 volts AC, 60 cycles. 150 watts at zero signal output; 210 watts at rated output.

FRONT PANEL INFORMATION

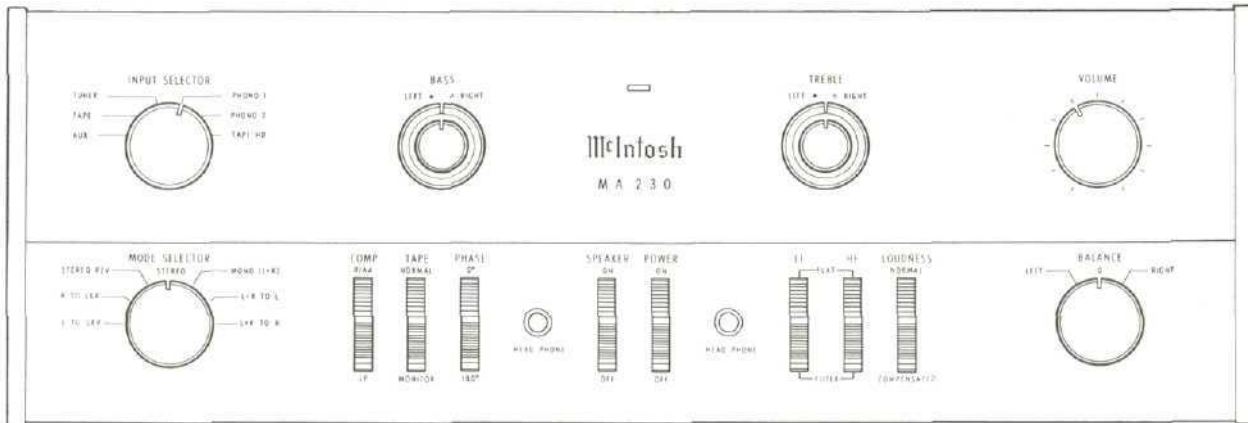

Figure 1. MA230 Front Panel.

INPUT SELECTOR

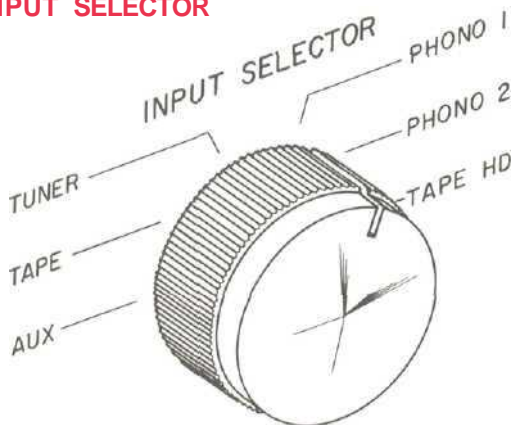

Figure 2. INPUT SELECTOR Switch.

Select any of six program sources with the MA230 INPUT SELECTOR switch.

1. **AUX:** Use the AUX position for any auxiliary program source requiring flat amplification, such as a tuner or television sound, connected to the back panel AUX input jacks.
2. **TAPE:** Use the TAPE position for a self-contained tape recorder (tape recorder having its own playback preamplifier), connected to the back panel TAPE input jacks.
3. **TUNER:** Use the TUNER position for any AM, FM, or FM stereo tuner connected to the back panel TUNER input jacks.
4. **PHONO 1:** Use the PHONO 1 position for any magnetic phono cartridge connected to the back panel PHONO 1 input jacks.
5. **PHONO 2:** Same as PHONO 1. (For example, PHONO 1 can be connected to a record changer while PHONO 2 is connected to a manual turntable.)

6. **TAPE HD:** Use the TAPE HD (Tape Head) position for a tape deck that does not have its own playback preamplifier. The Tape Head leads are connected to the back panel TAPE HD input jacks.

MODE SELECTOR

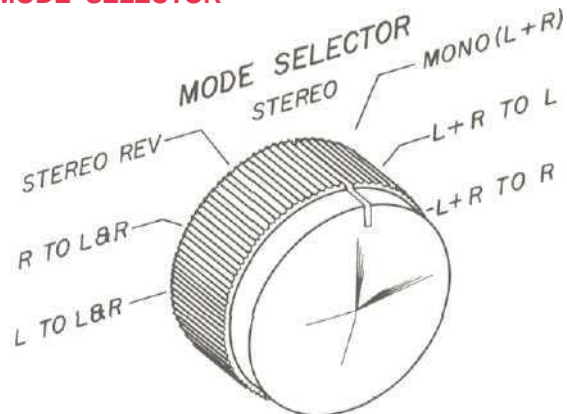

Figure 3. MODE SELECTOR Switch.

Use the MODE SELECTOR to:

- Listen to normal stereo (see 4 following and page 15);
- Reverse the left and right arrangement of musical instruments (see 3 following and page 15).
- Balance the amplifiers and loudspeakers in a stereo system (see 6 and 7 following and page 15).
- Listen to monophonic sound (see 1 and 2 following and page 15).
- Listen through both loudspeakers to either channel of a stereo program source (see 1 and 2 following and page 15).

Turn the MODE SELECTOR to:

1. L TO L & R: connects the "left" input to both loudspeakers.
2. R TO L & R: connects the "right" input to both loudspeakers.
3. STEREO REV: connects the "left" input to the "right" loudspeaker and the "right" input to the "left" loudspeaker.
4. STEREO: connects the "left" input to the "left" loudspeaker and the "right" input to the "right" loudspeaker.
5. MONO (L+R): adds the "left" input and the "right" input and then connects the L + R program to both amplifiers and loudspeakers.
6. L + R TO L: connects both left and right inputs to the "left" loudspeaker only.
7. L+ R TO R: connects both left and right inputs to the "right" loudspeaker only.

VOLUME

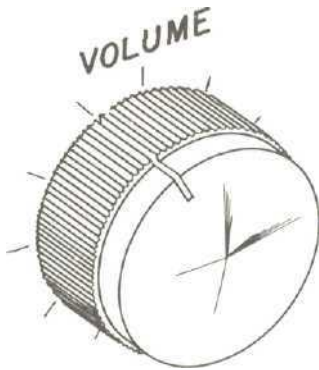

Figure 4. VOLUME Control.

Use the MA230 VOLUME control to regulate the volume level of both channels. Turning the VOLUME control clockwise increases volume level.

BALANCE

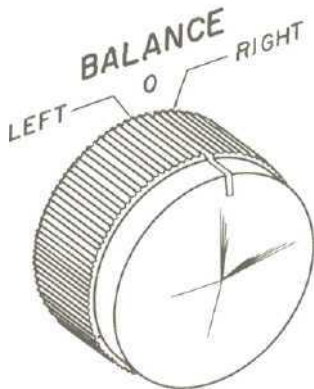

Figure 5. BALANCE Control.

Use the MA230 BALANCE control to balance unequal volume in the left and right channels of a program source. The volume of each speaker system relative to the other can be varied, at the same time the combined room volume level is not changed.

LEFT . . . turning the control to the left accents the left channel by reducing the right channel output.

RIGHT . . . turning the control to the right accents the right channel by reducing the left channel output.

BASS



Figure 6. BASS Control.

The BASS control is a dual-concentric control. The two are friction coupled. The center knob controls the left channel. The outer ring controls the right channel. With the BASS control it is possible to vary the bass loudness relationship existing between the left and right speakers. Both controls can be, turned together as a single adjustment or one may be held as the other is turned. Clockwise rotation increases bass loudness; counterclockwise rotation decreases bass loudness.

TREBLE

The TREBLE control is dual-concentric control. The two are friction-coupled. The center knob controls the left channel. The outer ring controls the right channel. With this control it is possible to vary the treble relationship existing between left and right speakers. Both controls can be turned together as a single adjustment or one may be held as the other is turned. Clockwise rotation increases treble loudness; counterclockwise rotation decreases treble loudness.



Figure 7. TREBLE Control.

COMP (Compensation)

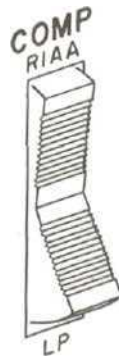

Figure 8. COMP (Compensation) Switch.

Use the COMP switch to correct for phono equalization introduced by the recording process. The recording industry has agreed to record all current LP and stereo recordings with RIAA equalization. On earlier stereo and on mono recordings use the position that sounds best to you.

TAPE

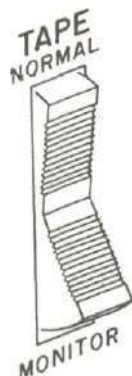

Figure 9. TAPE Switch.

The MA230 TAPE switch makes it possible to instantaneously compare recorded material with the source signal. Use the MA230 TAPE switch to know instantaneously, as you are recording, that the music on the tape is acceptable. Tape monitor jacks on the back panel accept a signal from a tape recorder with a monitor head and preamplifier.

NORMAL . . . the original program source is fed through the power amplifiers and the loudspeakers.

MONITOR . . . the recorded sound on the tape is fed through the power amplifiers and speakers.

PHASE

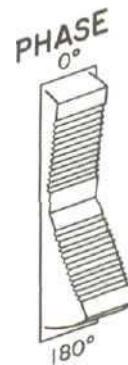

Figure 10. PHASE Switch.

The PHASE switch corrects for loudspeaker or program phasing. When this switch is in the 180° position the phase in the left channel is reversed.

SPEAKER

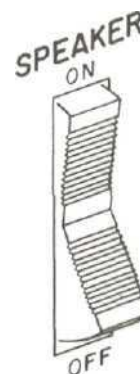
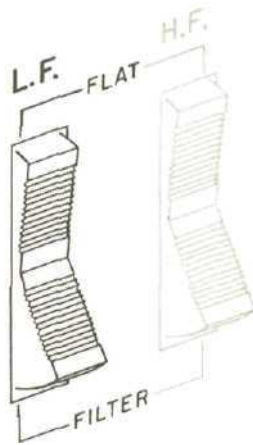

Figure 11. SPEAKER Switch.

The loudspeakers are turned off when the SPEAKER switch is in the OFF position, to allow listening through headphones. The headphone jacks are on at all times.

LF (Low Frequency Filter)



Use the LF filter to reduce low frequency noises created by a turntable, record changer, or vibration acoustically coupled to the phono player from the speakers.

FLAT... filter disconnected; flat response.

FILTER . . . low frequencies reduced sharply below 50 cycles.

HF (High Frequency Filter)

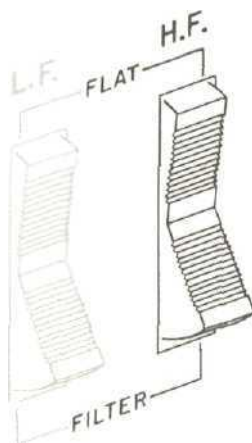

Use the HF filter to minimize surface noise when reproducing old or badly worn recordings.

FLAT... filter disconnected; flat response.

FILTER . . . high frequencies reduced sharply above 5000 cycles.

LOUDNESS

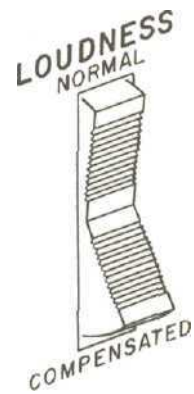

When you turn down the volume, music seems to lose much of its bass and some of its treble. This effect is due to the sensitivity characteristics of human hearing. The response of the human ear to bass and treble pitch decreases more rapidly than its response to the mid-tonal range. The LOUDNESS switch automatically provides the correct amount of bass and treble boost required to compensate for this change in response of the human ear at low loudness levels. Use the LOUDNESS switch in the COMPENSATED position to listen at low volume and still hear full frequency range.

HEADPHONE

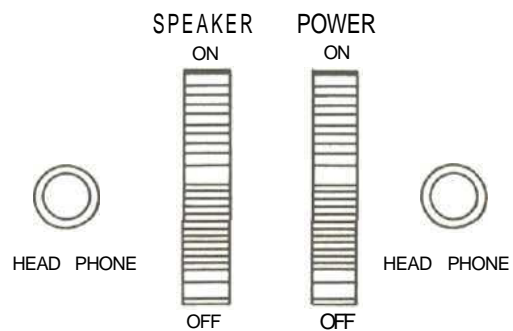

Two pairs of low impedance stereo headphones can be connected to the MA230. Both front panel headphone jacks are connected to the MA230 output through 100 ohm resistors. These resistors provide the correct output volume level for headphone operation.

INSTALLATION

The MA230 can be installed in furniture cabinets, custom built installations or professional relay racks. If the unit is to be used on a shelf or table top, it can be housed in an attractive McIntosh cabinet.

Allow sufficient cabinet space for air circulation. Minimum internal cabinet dimensions should be at least 16 inches wide, 14 inches deep, and 6 inches high. The back of the cabinet should be left as open as possible for ventilation. Proper ventilation will insure your amplifier a long and trouble-free life,

The MA230 installs conveniently from the front of the cabinet into the panel cutout. Two amplifier mounting brackets are provided for each side of the cabinet panel opening so the MA230 can slide easily into position. The mounting brackets are attached to the cabinet panel by two mounting strips. The mounting strips are attached to the back of the cabinet panel on each side of the panel cutout. With the screws supplied, front cabinet mounting panels up to one inch thickness may be used. Two knurled screws placed into the MA230 back panel, through the mounting brackets, hold the unit firmly in place. Due to the weight of the MA230, it is recommended that the mounting brackets rest on a wooden shelf in the cabinet for added support.

The design of the mounting template allows the cutout to be located either from the front or the back of the cabinet panel. Since the MA230 should rest on a shelf, locate the cutout from the back of the panel.

1A. Position the MA230 mounting template on the cabinet panel area to be cutout for the installation.

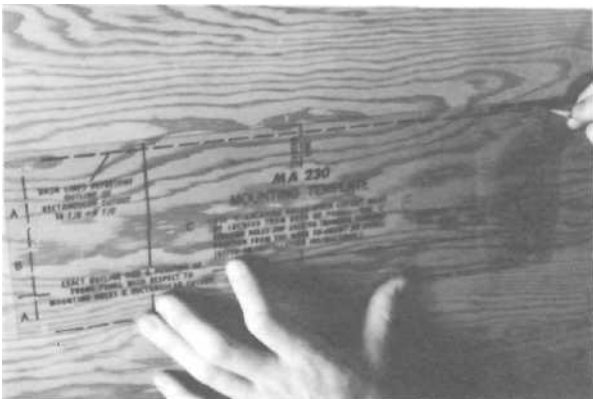

Figure 17. Positioning the Mounting Template over proposed area to be cutout.

1B. On the back of the cabinet panel, scribe a vertical line through the exact center of the cutout area.

Place the template against the back of the panel. Match the template centerline with the scribed cutout centerline. The bottom of the template must rest on the shelf.

1C. On each side of the centerline of the template there are two holes marked "C." The smaller diameter hole is below the larger diameter hole. These are the "LOCATING HOLES." These holes are used to locate the front panel of the MA230 with reference to the shelf behind the cabinet panel. So that the MA230 will rest on the cabinet shelf, follow these instructions carefully.

Mark the back of the cabinet panel with a pointed instrument through the two small diameter "LOCATING C" holes. Drill these two holes through the cabinet panel with a $\frac{3}{16}$ " diameter drill. Be certain the drill is perpendicular to the panel.

Now position the template on the front of the panel. Align the larger $\frac{3}{16}$ " diameter upper "LOCATING C" holes in the template with the drilled holes in the cabinet panel.

2. Mark the "A" and "B" drill holes and also the four corner cutouts in the template. Join the corner markers. The edge of the template can be used as a straight edge.



Figure 18. Marking the Cutout Indications.

3. First drill the mounting holes.

4. Cut out the rectangular opening.

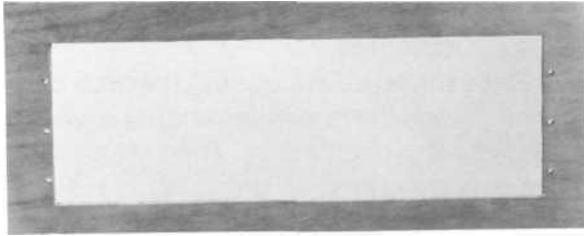

Figure 19. Installation Cutout.

5. Secure the mounting strips to the inside of the panel.

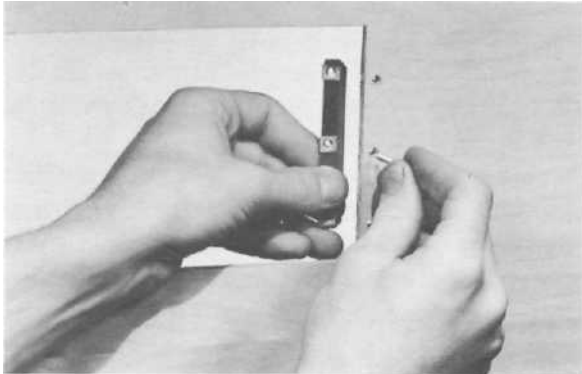

Figure 20. Securing Mounting Strips to Installation Cutout.

In the hardware package are 4 flat head screws and 8 fillister head screws. Two of the flat head screws of the proper length are used to attach the mounting strips to the cabinet panel. Four of the fillister head screws are used to attach the MA230 mounting brackets to the cabinet panel and the mounting strips behind the panel. The $\frac{1}{4}$ inch screws are used for panel thickness less than $\frac{3}{8}$ inch. The $1\frac{1}{4}$ inch screws are used with panels from $\frac{3}{8}$ inch to 1 inch in thickness.

Insert the proper length flat head screw through the center "B" holes of the cabinet panel ("B" holes marked on mounting template). Position the mounting strip behind the cabinet panel. The edge of the mounting strip that has the clips must be facing the rectangular cutout. Align the three holes in the mounting strip with the holes in the cabinet panel.

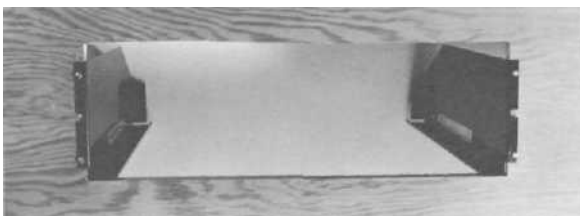

Figure 21. Mounting Brackets installed in cabinet panel.

Tighten the flat head screw so that the screw head pulls in the wood panel level with the panel surface. Repeat this with the second mounting strip on the other side of the rectangular cutout.

6. Left and right metal mounting brackets are packed with the MA230. Fasten these two mounting brackets to the cabinet panel using four of the fillister head screws. These screws should pass through the mounting shelf flange, through the cabinet panel and then into the mounting strip attached to the inside of the panel. Tighten the screws firmly, but do not over-tighten.

7. Prepare the MA230 for mounting by removing the four plastic feet fastened under the chassis.

8. The MA230 is installed from the FRONT of the cabinet. Insert the MA230 power cord through the rectangular opening of the cabinet panel. Carefully slide the MA230 into the opening so the plastic rails on the bottom of the chassis engage the grooves in the metal mounting brackets. Slide the MA230 in until its front panel is against the cabinet mounting panel.

9. Secure the MA230 to the mounting brackets by inserting the two knurled screws into the back of the MA230 chassis, through the back flanges of the mounting brackets.

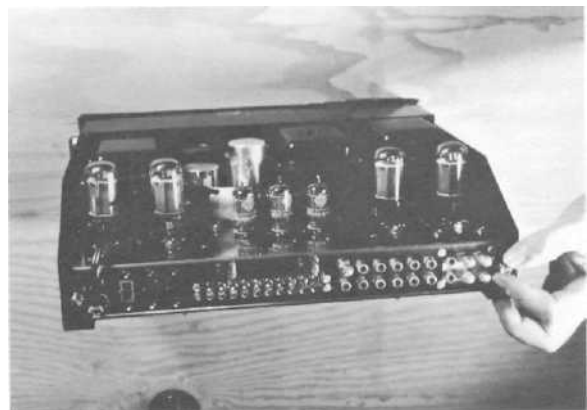

Figure 22. Securing MA230 to Mounting Brackets.

CONNECTING

AC CONNECTIONS

There are three AC outlets on the back panel of the MA230. The black receptacles have a maximum power rating of 350 watts total. The power to the two black receptacles is controlled by the front panel power switch. Use these receptacles for accessories such as a tuner and tape recorder. The red receptacle is not switched. Use the red receptacle for powering a turntable or record

changer. The red receptacle is not switched to prevent turning off the power to the turntable while its idler drive is still engaged. The turntable is protected by this arrangement because it is necessary to turn off the turntable with its own control switch. The turntable drives will then be properly disengaged to avoid possible damage.

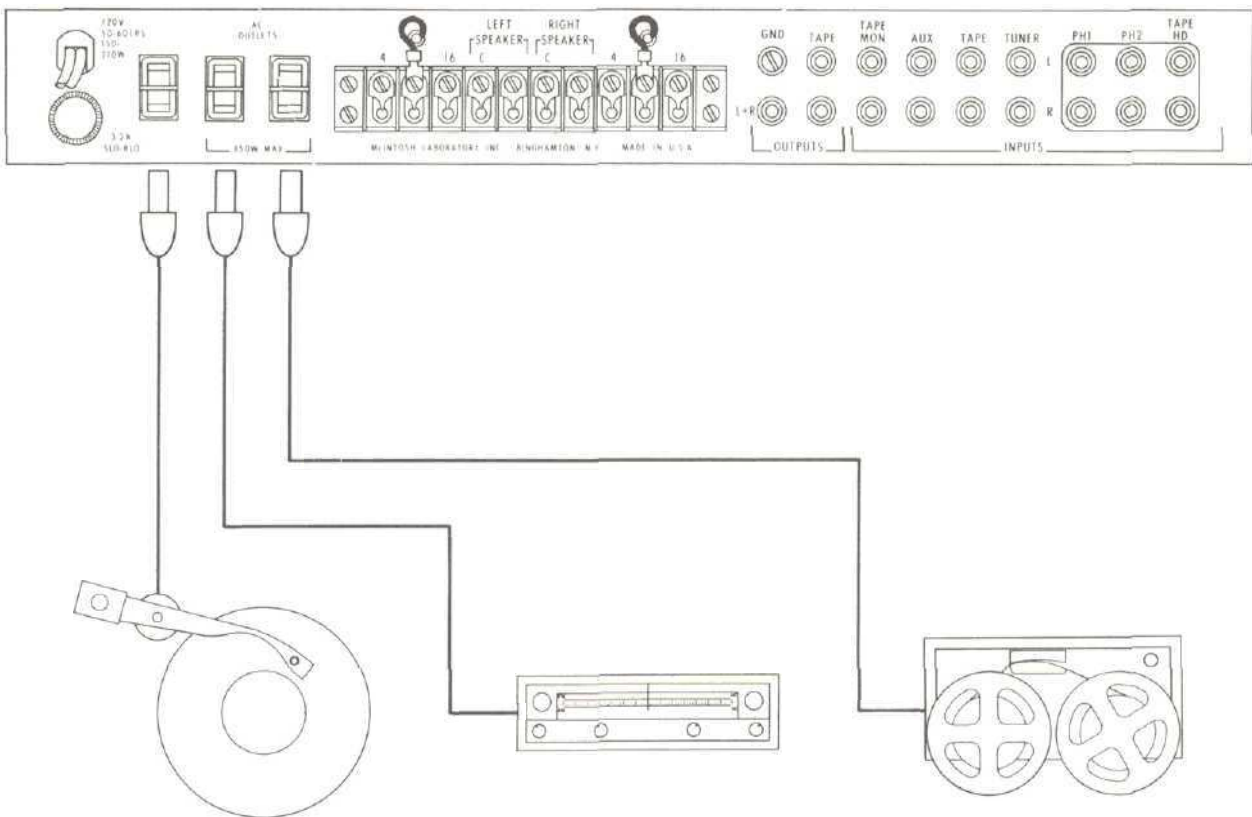

Figure 23. AC CONNECTIONS

L+R OUTPUT

Both left and right channel amplifier outputs are combined into a monophonic signal at the L+R output jack. Connect this jack to an external amplifier for monophonic reproduction through another speaker system. Monophonic signals can then be distributed to other rooms without affecting the normal stereo performance of the MA230.

GROUND CONNECTIONS

A single ground post is provided on the MA230. The chassis ground from turntables, record changers, tape decks, etc., should be connected to this post. Do not connect other ground wires to the same units. Hum is likely to be heard in the system if more than one ground circuit is used.

The left and right cables from each pro-

gram source should be twisted together and the ground wire from each source can be wound or twisted in with these cables. To avoid hum, make sure the ground wire does not make any connections to shields of the left and right channel cables except for the connection provided with the MA230 ground post.

TAPE OUTPUT CONNECTIONS

The TAPE OUTPUTS on the back panel provide the program material with sufficient level for feeding a tape deck or recorder. The TAPE OUTPUT signal is not affected by these front panel controls: VOLUME, BASS, TREBLE, BALANCE, LOUDNESS, PHASE, TAPE, MODE SELECTOR, SPEAKER, LF and HF FILTERS. The INPUT SELECTOR and the COMP switch (in Phono 1 and Phono 2) affect the TAPE OUTPUTS. All recording volume adjustments are made at the tape recorder. The room listening volume of the MA230 can

then be set at any desired level without affecting recording volume.

LEFT and RIGHT SPEAKER OUTPUT

Speaker systems of 4, 8, or 16 ohms impedance connect to the SPEAKER terminals on the back panel of the MA230.

Select the output impedance desired by placing the wire pigtail with the lug under the appropriate impedance screw on each channel. Tighten the screws firmly. Connect the left speaker leads to the two screws under the lettering marked LEFT SPEAKER. Connect the right speaker leads to the two screws under the lettering marked RIGHT SPEAKER. The common or chassis ground tap on each channel is marked C. Connect each speaker in an identical manner.

AC POWER

Plug the AC power cord into a 120-125 volt, 50 or 60 cycle power line.

INPUT CONNECTIONS

The MA230 provides seven separate program inputs controlled by the INPUT SELEC-

TOR switch. The input for tape monitor is controlled by the TAPE switch.

CONNECTION	FUNCTION	INPUT SENSITIVITY	INPUT IMPEDANCE
TAPE MONITOR	The tape monitor input accepts a signal from a tape recorder with a monitor head and preamplifier.	0.25 V	250K
AUX	The auxiliary input accepts any auxiliary service requiring flat frequency response, such as a T.V. set, tuner, tape recorder with its own playback preamplifier, etc.	0.25 V	250K
TAPE	The tape input operates with tape machines containing their own playback preamplifier.	0.25 V	250K
TUNER	The tuner inputs accept AM and FM outputs from a stereo tuner or a pair of stereo tuners or the multiplex output of an adapter of multiplex tuner.	0.25 V	250K

CONNECTION	FUNCTION	INPUT SENSITIVITY	INPUT IMPEDANCE
PHONO 1 & 2	These jacks are to be used with magnetic cartridges,..	1.5 MV	47K
TAPE HEAD	These jacks are to be used with a tape deck that does not contain its own playback preamplifier.	1.5 MV	1 megohm

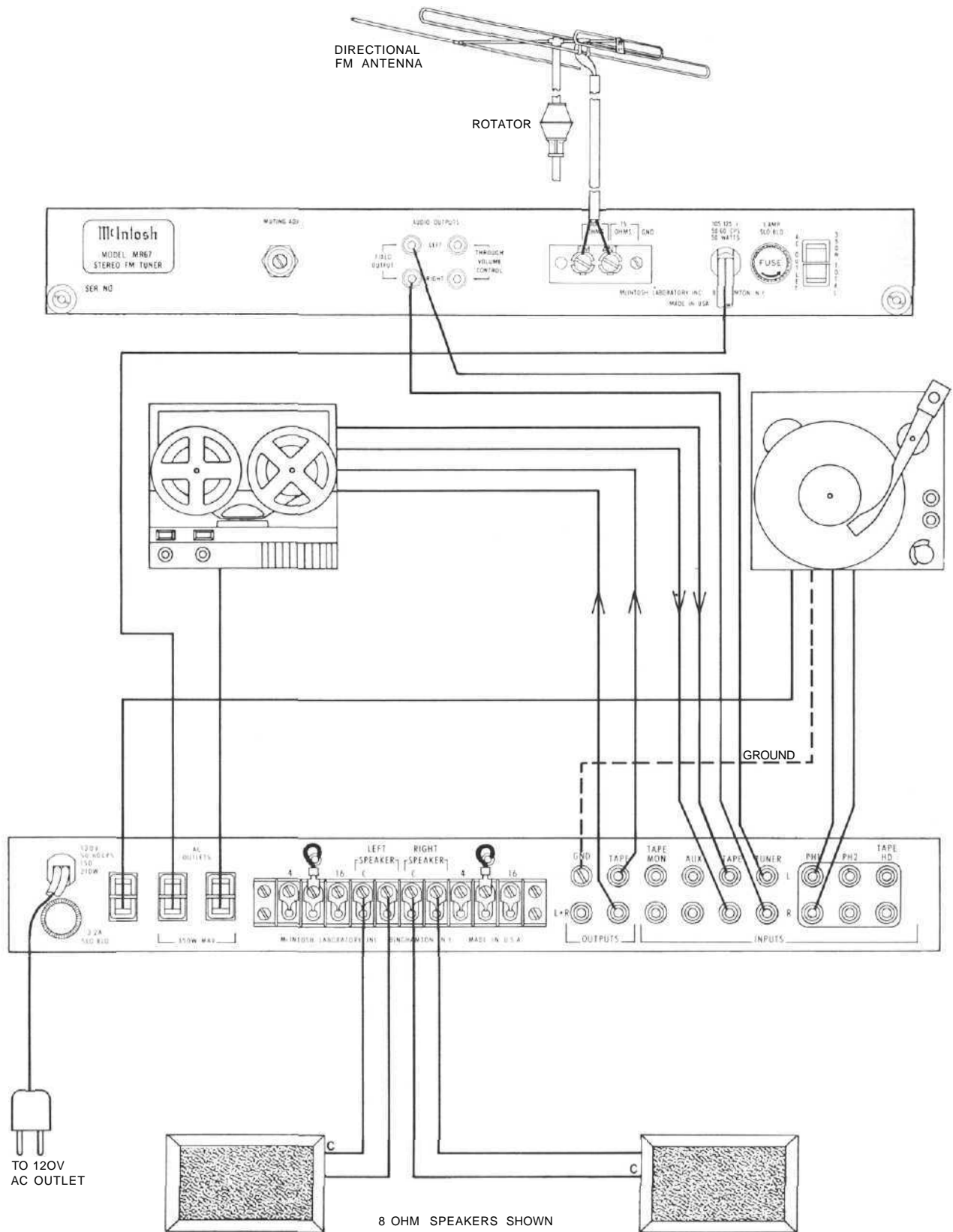

If a phono cartridge requires less than 47,000 ohms load impedance, a resistor can be added across the terminals of the car-

tridge to achieve the correct termination. The following chart may be used as a guide:

Desired Impedance

47,000 ohms (47K)
37,000 ohms (37K)
27,000 ohms (27K)
15,000 ohms (15K)
6,800 ohms (6.8K)

Resistor Across Input

No Resistor
180,000 ohms (180K)
62,000 ohms (62K)
22,000 ohms (22K)
8,200 ohms (8.2K)

OPERATING INSTRUCTIONS

BALANCING A STEREO SYSTEM

The performance and enjoyment of a stereo system is greatly increased when the system is properly balanced. The balance of a stereo system is affected by many things including room acoustics, furniture placement, room shape, small differences in loudspeakers, and unequal program loudness.

The control marked BALANCE on the MA230 can be used to perfectly balance all factors for best listening.

1. Play a familiar recording on the record player.
2. Turn the INPUT SELECTOR to the PHONO position into which the record player is connected.
3. Turn the BASS and TREBLE controls so that the knob indicators are centered between the panel markings L and R.
4. Turn the BALANCE control to the center or 12 o'clock position.
5. Place the LOUDNESS switch in the NORMAL position.
6. Place the TAPE switch in the NORMAL position.
7. Place the PHASE switch in the 0° position.

8. Place the LF filter switch in the FLAT position.

9. Place the HF filter switch in the FLAT position.

10. Turn the MODE SELECTOR to the L+R to L position.

11. While the program is playing, alternate the MODE SELECTOR between the L+R to R and the L+R to L positions. Adjust the MA230 BALANCE control until the loudspeaker volumes are equal.

The stereo system will now be balanced. Different program material such as records, tapes or FM broadcasts may require different BALANCE control settings. It is not at all unusual for the BALANCE control to remain off center one way or the other for correct balance. This means the BALANCE control is performing the function it was designed for.

ADJUSTING PHASE

1. Set the MODE SELECTOR to STEREO.
2. Turn the BASS controls and TREBLE controls to straight up position with the dial indicators centered between the panel markings L and R.
3. Stand approximately 10 feet in front of and midway between the loudspeakers. The

source of sound should appear to be directly in front of you. Alternate the PHASE switch between 0° and 180°. If the sound is not directly in front of you in the 0° position, reverse the leads to one loudspeaker. The PHASE switch is used to correct phase in the source material whenever necessary.

ADJUSTING FOR SPECIAL EFFECTS

HF FILTER

If you wish to reproduce badly worn records, you can minimize the surface noise by switching the HF filter to the FILTER position.

LF FILTER

If you are using a turntable or changer which has low-frequency rumble noise, you may reduce it by pushing the LF filter switch to the FILTER position.

BASS CONTROLS AND TREBLE CONTROLS

The tone balance which you hear when listening to an orchestra is affected by the conductor's instructions to his musicians, the acoustical environment in which you are listening, and your own subjective hearing interpretation. Considering these conditions, it is easy to see why tone balance controls play a major role in correcting for the following factors:

1. Each person's subjective idea of tone balance.
2. Loudspeaker frequency response characteristics.
3. Loudspeaker placement in the listening room.
4. The conductor's idea of tone balance at the time the recording was made.
5. The microphone frequency response characteristics.
6. The recording process influences.

These factors can be considered as environmental influences. The BASS CONTROLS and TREBLE CONTROLS provide a degree of compensation for effects of environment. Listen to your system with each control set with the indicators centered between the panel markings L and R. If you wish to reduce treble in relation to bass for example, turn the TREBLE CONTROLS counterclockwise until the tone balance sounds correct to you. These controls will modify

tone balance without introducing any undesirable effects. Do not be surprised if you find your preference in tone changing from time to time.

PHASE

If the stereo sound seems to come from either side of the room instead of being distributed between the loudspeakers, turn the PHASE switch to 180°. This listening effect is due to reproducing sound that is out of phase from one channel to the other. You will find some records and tapes may differ from others in this respect.

LISTENING TO A STEREO TUNER

1. Turn the INPUT SELECTOR to TUNER.
2. Turn the MODE SELECTOR to STEREO.
3. Set the PHASE switch to 0°.
4. Set the HF cutoff filter switch to FLAT. (See page 15 ADJUSTING FOR SPECIAL EFFECTS.)
5. Set the LF filter switch to FLAT. (See page 15 ADJUSTING FOR SPECIAL EFFECTS.)
6. Set the LOUDNESS switch to NORMAL. (See page 15 ADJUSTING FOR SPECIAL EFFECTS.)
7. Turn the BASS CONTROLS and TREBLE CONTROLS so that the indicators are centered between the panel markings L and R. (See page 15 BASS AND TREBLE CONTROLS.)
8. Set the TAPE switch to NORMAL.
9. Adjust the VOLUME control to the desired volume.
10. Adjust the BALANCE control if necessary.

After a warm up of about 30 seconds, turn the tuning knob on your tuner to find the station of your choice.

LISTENING TO A STEREO RECORD

To listen to stereo records, proceed as follows:

1. Turn the INPUT SELECTOR to PHONO 1 or PHONO 2, whichever is connected to the cartridge you wish to hear.
2. Set the MODE SELECTOR to STEREO.
3. Set the PHASE switch to 0°.
4. Set the HF cutoff filter switch to FLAT.

(See page 15 ADJUSTING FOR SPECIAL EFFECTS.)

5. Set the LF filter switch to FLAT. (See page 15 ADJUSTING FOR SPECIAL EFFECTS.)

6. Set the LOUDNESS switch to NORMAL. (See page 15 ADJUSTING FOR SPECIAL EFFECTS.)

7. Set the TAPE switch to NORMAL.

8. Set the BASS CONTROLS and TREBLE CONTROLS so that the indicators are centered between the panel markings L and R. (See page 15 BASS and TREBLE CONTROLS.)

9. Adjust the VOLUME control to the desired volume.

10. Adjust the BALANCE control if necessary.

LISTENING TO MONOPHONIC RECORDS

To listen to monophonic records, proceed as follows:

1. Turn the INPUT SELECTOR to PHONO 1 or PHONO 2, whichever is connected to the cartridge you wish to hear.

2. Turn the MODE SELECTOR to MONO (L+R).

3. Set the PHASE switch to 0°.

4. Set the HF cutoff filter switch to FLAT. (See page 15 ADJUSTING FOR SPECIAL EFFECTS.)

5. Set the LF filter switch to FLAT. (See page 15 ADJUSTING FOR SPECIAL EFFECTS.)

6. Set the LOUDNESS switch to NORMAL. (See page 15 ADJUSTING FOR SPECIAL EFFECTS.)

7. Set the BASS CONTROLS and TREBLE CONTROLS so that the indicators are centered between the panel markings L and R. (See page 15 BASS AND TREBLE CONTROLS.)

8. Adjust the VOLUME control to the desired volume.

9. Adjust the BALANCE control if necessary.

LISTENING TO TAPE DECKS

To listen to tape from a tape deck, proceed as follows:

1. Turn the INPUT SELECTOR to TAPE HEAD.

2. Turn the MODE SELECTOR to MONO (L+R) or STEREO, depending on the program on the tape.

3. Set the PHASE switch to 0°.

4. Set the HF cutoff filter switch to FLAT. (See page 15 ADJUSTING FOR SPECIAL EFFECTS.)

5. Set the LF filter switch to FLAT. (See page 15 ADJUSTING FOR SPECIAL EFFECTS.)

6. Set the LOUDNESS switch to NORMAL. (See page 15 ADJUSTING FOR SPECIAL EFFECTS.)

7. Set the BASS CONTROLS and TREBLE CONTROLS so that the dial indicators are centered between the panel markings L and R.

8. Adjust the VOLUME control to the desired volume.

9. Adjust the BALANCE control if necessary.

LISTENING TO A STEREO TAPE MACHINE

A stereo tape machine with its own playback preamplifiers should be plugged into the AUX input or the TAPE MONITOR input—not the TAPE HEAD input.

If the TAPE input is used, proceed as follows:

1. Turn the INPUT SELECTOR to TAPE.

2. Turn the MODE SELECTOR to MONO, (L+R) or STEREO depending on the program on the tape.

3. Set the PHASE switch to 0°.

4. Set the HF cutoff filter switch to FLAT. (See page 15 ADJUSTING FOR SPECIAL EFFECTS.)

5. Set the LF filter switch to FLAT. (See page 15 ADJUSTING FOR SPECIAL EFFECTS.)

6. Set the LOUDNESS switch to NORMAL. (See page 15 ADJUSTING FOR SPECIAL EFFECTS.)

7. Set the BASS CONTROLS and TREBLE CONTROLS so that the dial indicators are centered between the panel markings L and R.

8. Adjust the VOLUME control to the desired volume.

9. Adjust the BALANCE control if necessary.

If the AUX input is used, turn the INPUT SELECTOR to AUX; then, proceed the same

as for TAPE input.

1. Set the TAPE MONITOR switch to MONITOR.
2. Turn the MODE SELECTOR switch to MONO (L+R).
3. Set the HF cutoff filter switch to FLAT. (See page 15 ADJUSTING FOR SPECIAL EFFECTS.)
4. Set the LF filter switch to FLAT. (See page 15 ADJUSTING FOR SPECIAL EFFECTS.)
5. Set the LOUDNESS switch to FLAT. (See page 15 ADJUSTING FOR SPECIAL EFFECTS.)
6. Set the BASS CONTROLS and TREBLE CONTROLS so that the dial indicators are centered between the panel markings L and R.
7. Adjust the VOLUME control to the desired volume.
8. Adjust the BALANCE control if necessary.

POWER

The POWER ON-OFF switch controls the AC power to the MA230 and the two black AC receptacles on the back panel. The red AC receptacle is not switched, and is on at all times.

HEADPHONE

Two pairs of low impedance stereo headphones can be connected to the MA230. Both front panel headphone jacks are connected to the MA230 output through 100 ohm resistors. These resistors provide the correct output volume level for headphone operation.

ADJUSTMENTS

Two simple circuit adjustments are included in the MA230. After extensive use or when tubes have been replaced, these adjustments will insure top performance from your MA230.

The DC bias of each 7591 output tube can be individually set. Test Point jacks and bias adjust controls are conveniently mounted on the chassis next to each output tube. The output tubes, Test Point jacks, and bias controls are marked V, TP, and R, respectively. The bias adjust control can be reached from the top of the chassis with a small screwdriver. Set the Bias controls for a DC voltage of 0.7 volts from each Test Point jack to chassis ground. Use a VTVM or sensitive DC

voltmeter. Check all voltages a second time and readjust the controls if necessary.

A phase inverter AC signal balance control is provided on each amplifier channel. These controls are factory set with a harmonic distortion analyzer for minimum distortion at 20 cycles at 30 watts output. Normally just a midpoint setting of these controls is adequate to keep overall distortion to less than 0.5% at full output. If the necessary distortion measuring equipment is available, set each control for minimum harmonic distortion at 20 cycles at 30 watts output. Balance control R4 adjusts the left channel signal balance, and R5 the right channel balance.

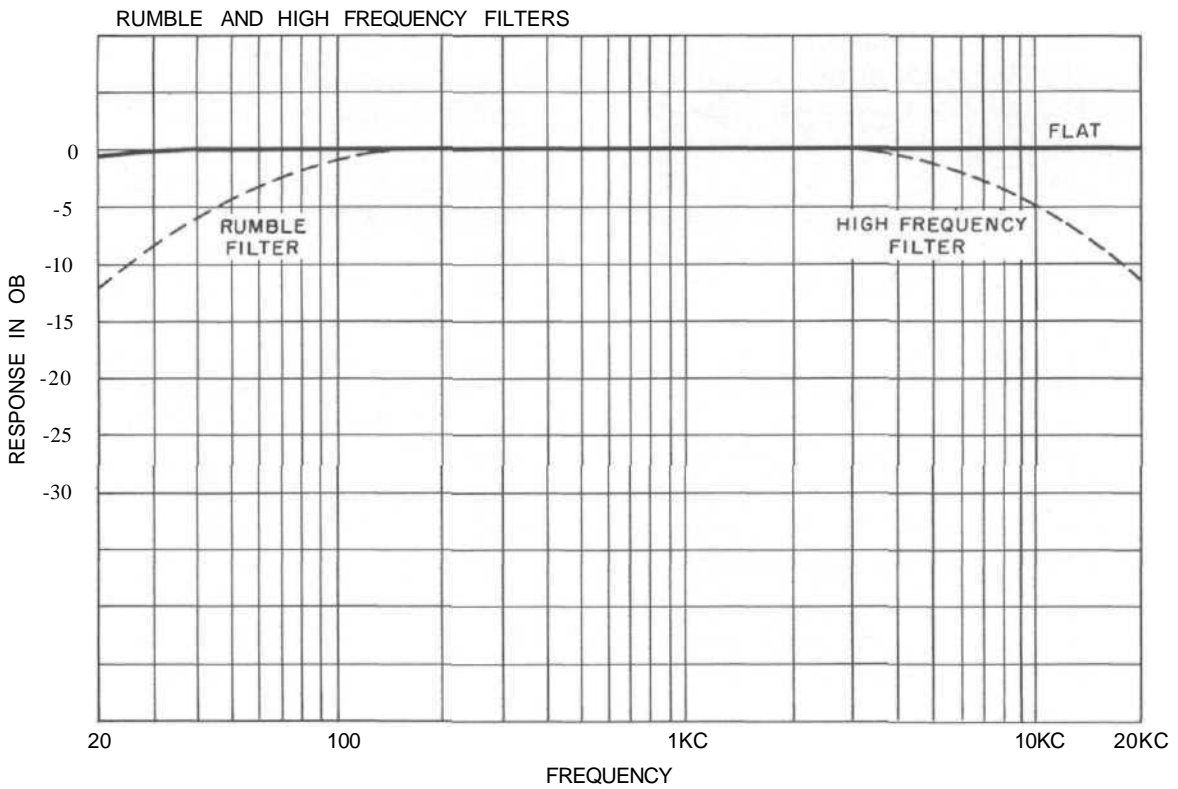
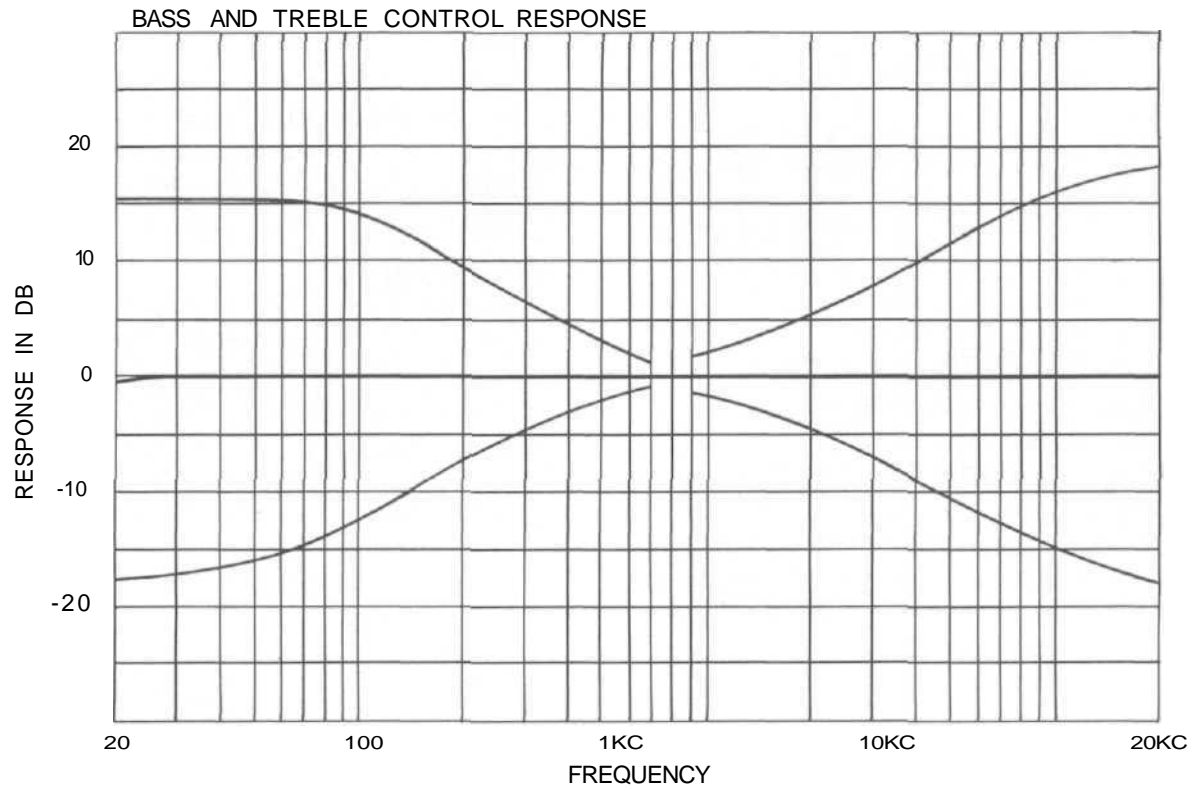

LOUDNESS CONTROL

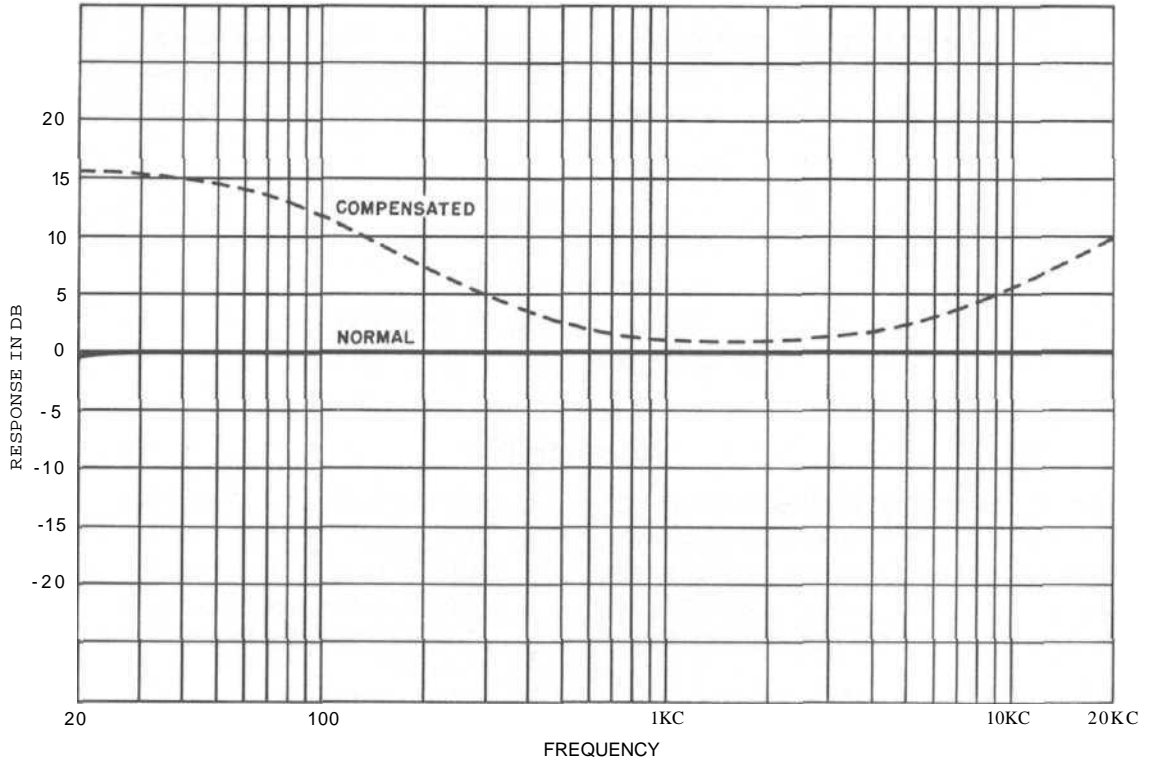

EQUALIZATION CURVES

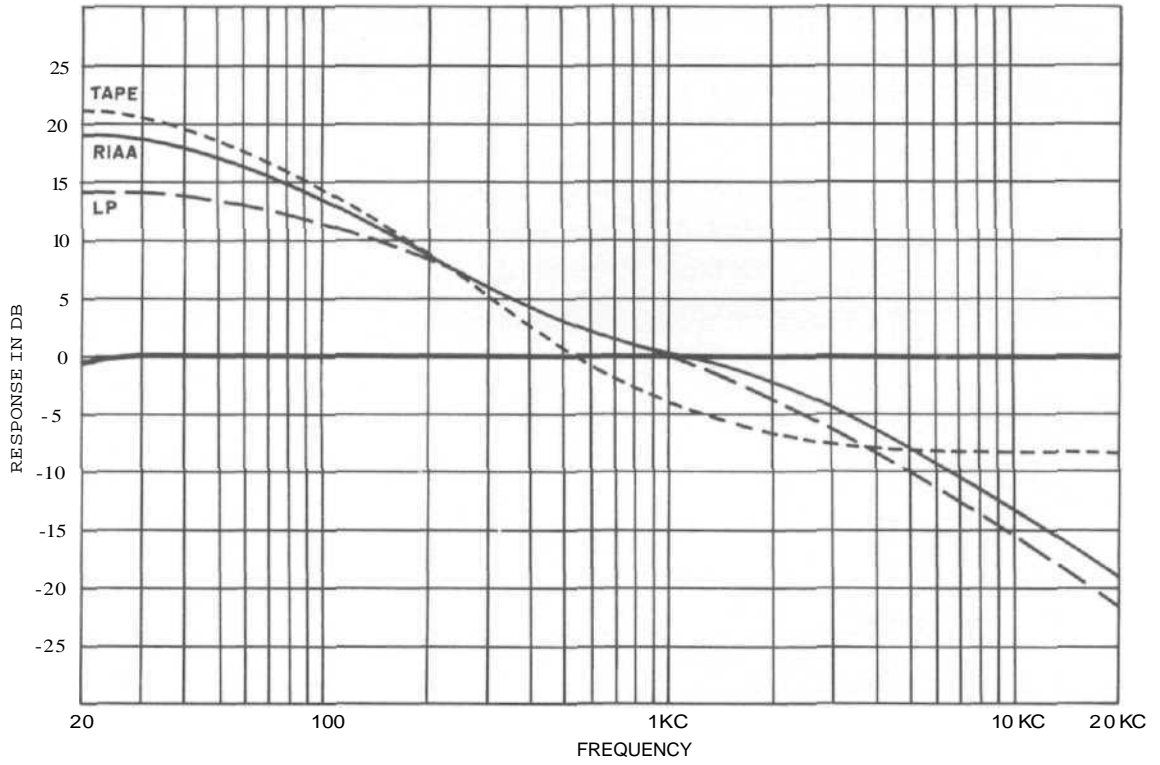

Your McIntosh MA230 tuner will give you many years of pleasant and satisfactory performance. If you have any questions concerning the operation or maintenance of this tuner please contact:

Customer Service
McIntosh Laboratory Inc.
2 Chambers Street
Binghamton, New York
Our telephone number is 723-5491.
The direct dial area code is 607.

GUARANTEE

McIntosh Laboratory Incorporated guarantees this equipment to perform as advertised. We also guarantee the mechanical and electrical workmanship and components of this equipment to be free of defects for a

period of 90 days from date of purchase. This guarantee does not extend to components damaged by improper use nor does it extend to damage incurred during transportation to and from McIntosh Laboratory, Inc.

3-YEAR FACTORY SERVICE CONTRACT

An application for a FREE 3-YEAR FACTORY SERVICE CONTRACT is included in the pocket in the back cover of this manual. The FREE 3-YEAR FACTORY SERVICE CONTRACT will be issued by McIntosh Laboratory upon receipt of the completely filled out application form. The term of this contract is de-

fined in the 3-year factory service contract. If the application is not mailed to McIntosh Laboratory, only the services offered under the standard 90-day guarantee will apply on this equipment. TAKE ADVANTAGE OF 3 YEARS OF FREE FACTORY SERVICE BY FILLING IN THE APPLICATION NOW.

In Canada: manufactured under license by:
McCurdy Radio Industries, Ltd.
22 Front Street West
Toronto, Canada

McIntosh LABORATORY INC.

2 CHAMBERS STREET, BINGHAMTON, N. Y.

Made in U.S.A.

Phone-Area Code 607-723-5491